

USER GUIDE

LiFePO4 Battery System for Households

LiFePO4 Battery System for Households



Contents

1 ABOUT THIS MANUAL	1
1.1 Purpose	1
1.2 Scope	1
1.3 Safety Instructions	1
2 INTRODUCTION	2
2.1 Features.....	2
2.2 Product Overview	2
2.3 Specifications	4
2.4 Recommended Settings	4
3. INSTALLATION	5
3.1 Unpacking and Inspection	5
3.2 Mounting the Unit	5
3.3 Connection for Parallel Mode	6
4. OPERATION	9
4.1 Switch On/Off.....	9
4.2 Description for LED	9
4.3 ON / OFF or SOC Led (Mode or SOC)	10
4.4 DIP switch SW1-SW4 Description	10
5. EMERGENCY SITUATIONS	11
5.1 Fire	11
5.2 Leaking Batteries	11
5.3 Wet Batteries	11
5.4 Warranty	11

1 ABOUT THIS MANUAL

1.1 Purpose

This manual describes the introduction, installation, operation and emergency situations of the battery bank. Please read this manual carefully before installations and operations. Keep this manual for future reference.

1.2 Scope

This manual provides safety and installation guidelines as well as information on tools and wiring.

1.3 Safety Instructions



WARNING: This chapter contains important safety and operating instructions. Read and keep this manual for future reference.

- Before using the unit, read all instructions and cautionary markings on the unit, the batteries and all appropriate sections of this manual.
- CAUTION** --- To reduce risk of injury, damage, even burst, please use it following using manual. In case of causing personal
- Do not disassemble the battery. Take it to a qualified service center when service or repair is required. Incorrect re-assembly may result in a risk of fire.
- To reduce risk of electric shock, disconnect all wirings before attempting any maintenance or cleaning. Turning off the unit will not reduce this risk.
- CAUTION** – Only qualified personnel can install this device with inverter.
- For optimum operation of this battery, please follow required spec to select appropriate cable size.
- Be very cautious when working with metal tools on or around batteries. A potential risk exists to drop a tool to spark or short circuit batteries or other electrical parts and could cause an explosion or fire.
- Please strictly follow installation procedure.
- To support full output load, at least 2 sets of LPBF24V for inverter larger than 3KVA, and at least 2 sets of LPBF48V for inverter larger than 6KVA in parallel connection.
- GROUNDING INSTRUCTIONS** - This System should be connected to a permanent grounded wiring system. Be sure to comply with local requirements.
- NEVER** cause AC output and DC input short circuited. Do not connect to the mains when DC input short circuits.
- Warning!! Only qualified service persons are able to service this device.
- Battery should be installed indoor and kept away from water, high temperature mechanical force and flames.
- Do not install the battery in any environment of temperature below 0°C or over 55°C, and humidity over 80%.
- Do not put any heavy objects on the battery.

1.4 Can be connected in parallel

- The batteries can be connected in parallel. Series connection is not allowed. Use in upright position only.**
- The batteries are not allowed to connected with PWM controller for charging.**

Special Attention: Due to the built-in protection board of the lithium battery pack is with over-discharge protection function, it is strongly recommended to stop using the load when the battery pack is over-discharged. The battery pack cannot be repeatedly activated for discharge. Or the battery may be failed to be activated by the AC or PV activation cable (It requires a special charging activation method), so cannot be charged. Therefore, when the battery pack is low power, please charge the battery as soon as possible when main power or solar energy is available.

2. INTRODUCTION

The battery system main using Solar power system for Family house. It also have a with to controller the battery easily and protect our Household application timely.

2.1 Features

- Iron phosphate-lithium power battery
- Long warranty period:3 years
- Higher energy density, smaller volumn for household.
- Support connected in parallel mode for expansion
- Photovoltaic system: This battery pack is designed for household photovoltaic systems.
- Battery management system (BMS): The battery packs built-in BMS monitors its operation and prevents the battery from operating outside design limitations.
- Expandability: This battery pack can be easily expanded by adding expansion battery packs in parallel connection.

2.2 Product Over View

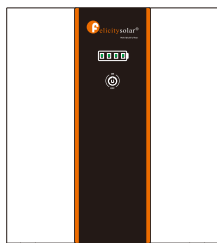

24V Front view

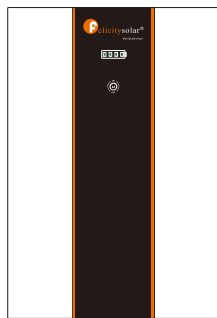

48V Front view

LPBF24150-S & LPBF24200-S & LPBF48150-S & LPBF48200-S

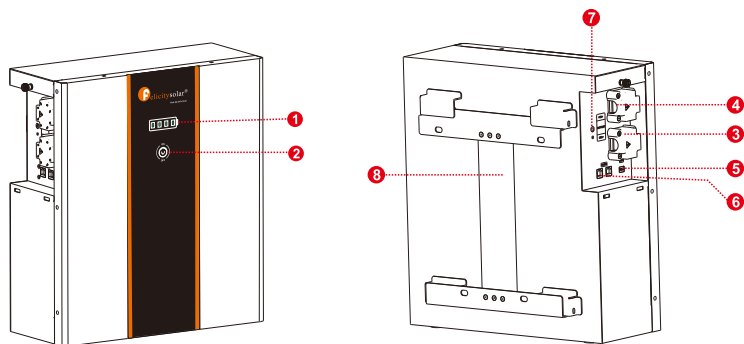

LPBF24100-S

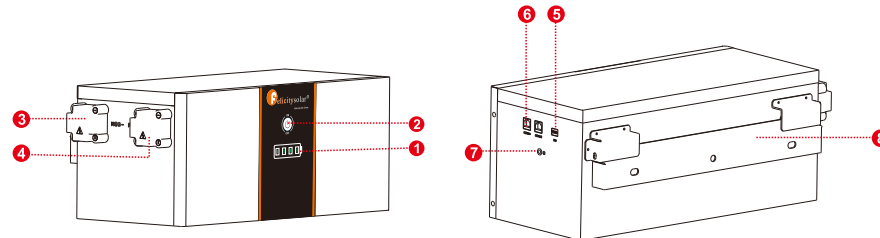

LPBF48100-S

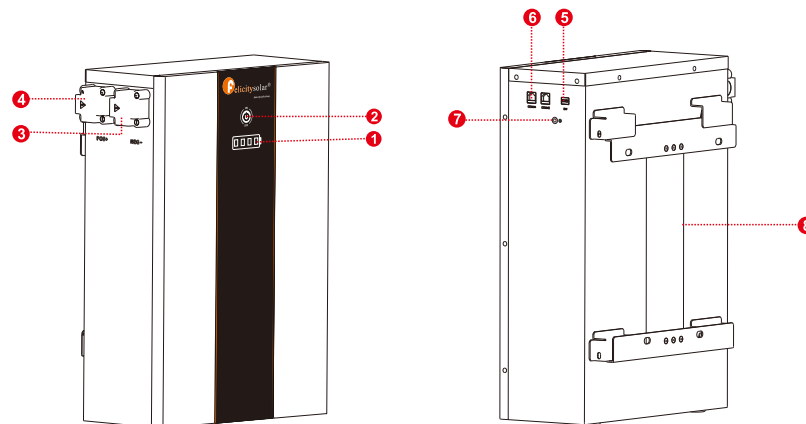

- | | | |
|-----------------------|--------------------------------|-----------------------|
| 1. LED display | 2. Power On/Charging indicator | 3. Battery Negative - |
| 4. Battery Positive + | 5. Switch | 6. Communication port |
| 7. Earth wire | 8. Wall mounted fixing | |

2.3 Specifications

Model	LPBF24100-S	LPBF24150-S	LPBF24200-S	LPBF48100-S	LPBF48150-S	LPBF48200-S
Usable Capacity	2.5KWH	3.75KWH	5KWH	5KWH	7.5KWH	10KWH
Nominal Voltage	25.6	25.6	25.6	51.2	51.2	51.2
Voltage Range	24-28.8	24-28.8	24-28.8	48-57.6	48-57.6	48-57.6
MAX. Charge & Discharge Current	100A@30S	120A@30S	120A@30S	100A@30S	120A@30S	120A@30S
Recommend Charge & Discharge Current	≤50A	≤60A	≤80A	≤50A	≤60A	≤80A
MAX. Output Power	2500W	3000W	3000W	5000W	6000W	6000W
Recommend Output Power	1250W	1500W	2000W	2500W	3000W	4000W
DOD	≥95%					
Modules Connection	1~6in parallel					
Communication	CAN&RS485					
Ingress Protection	IP21					
Cycle Life	≥3000@25°C, 80%DOD					
Working Temperature Range	Discharge:-20°C to +65°C, Charge:+0°C to +55°C					
Net Weight(KG)	23.5KG	48KG	48KG	46KG	93KG	93KG
Gross Weight(KG)	25.8KG	53KG	53KG	51KG	99KG	99KG
Product Dimension(MM)	514*251*209MM	500*450*213MM	500*450*213MM	555*413*203MM	800*545*213MM	800*545*213MM
Package Dimension(MM)	572*312*297MM	622*572*298MM	622*572*298MM	677*502*288MM	922*667*298MM	922*667*298MM

2.4 Recommended Settings

Lithium battery pack is not same as lead-acid battery, so for the devices which you connect with the battery pack for charging or discharging, such as inverters, MPPT charger controllers or UPS, please implement pre-settings as recommended settings as below before you launched them.

Setting	LPBF24100-S	LPBF24150-S	LPBF24200-S	LPBF48100-S	LPBF48150-S	LPBF48200-S
Max. Charging Voltage	28.8V			57.6V		
Floating charging Voltage	28.8V			57.6V		
Max. Charging Current	50A*N	80A*N		50A*N	80A*N	
Cut-off voltage	24V			48V		

Notes: "N" means the number of battery packs connected in parallel.

3. INSTALLATION

3.1 Unpacking and Inspection

Before installation, please inspect the unit. Be sure that nothing inside the package is damaged. You should have received the following items inside of package.

NO	NAME	SPECIFICATION	PICTURE
1	Wall mount	Wall mount bracket	
2	Communication line 1	Grid activation communication wire (used with 6)	
3	Communication line 2	Used for Communication among batteries	
4	Communication line 3	Used for communication between battery and host computer	
5	Cables	Used for battery parallel connection	
6	Adapter	Used for activating the pack when grid power recover	
7	Screw	Mounting screw	
8	PV Wake up line	Used for auto restart when PV comeback in off-grid system	
9	User manual	User manual	
10	Guarantee card	Guarantee card	
11	Handle	Handle	

NOTE: ①②③④⑤⑥⑦⑧⑨⑩⑪ in LPBF48150-S&LPBF48200-S

①②③④⑤⑥⑦⑧⑨⑩ in LPBF24100-S&LPBF24150-S&LPBF24200-S&LPBF48100-S

3.2 Mounting the Unit

Consider the following points before selecting where to install:

- Do not mount the battery on flammable construction materials.
- The ambient temperature should be between 0°C and 45°C to ensure optimal operation.
- The recommended installation position is to be adhered to the wall vertically.
- Be sure to keep other objects and surfaces as shown in the right diagram to guarantee sufficient heat dissipation and to have enough space for removing wires.

	LPBF 24100-S
A	80
B	160
C	160
D	102
E	209
F	107

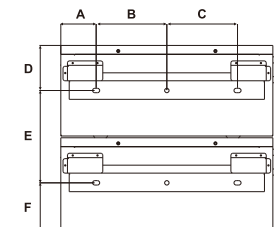

	LPBF24150-S	LPBF24200-S	LPBF48100-S	LPBF48150-S	LPBF48200-S
A	105	105	70	92.5	92.5
B	240	240	240	320	320
C	123	123	128	232.5	232.5
D	301	301	301	401	401
E	203	203	258	403	403
F	301	301	301	401	401
G	80	80	130	170.5	170.5
H	155	155	120	132.5	132.5
I	140	140	140	240	240

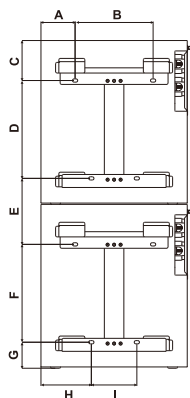

Please follow below steps to implement battery connection:

1. Assemble battery ring terminal based on recommended battery cable and terminal size.
2. Connect all battery packs as units requires. It's suggested to connect at least 2 sets of LPBF24V for inverter larger than 4KVA/5KVA model, and at least 2 sets of LPBF48V for inverter larger than 7.5KVA in parallel connection

Note: if you need the battery wake-up when the grid back, connect the battery with grid use power adapter and communication line 1 shown in the package list.

3.3 Connection for Parallel Mode

The eStrong LPBF series battery support to be connected in parallel for expansion. If you need one more battery bank work in parallel mode, connect the battery as shown in PIC 2

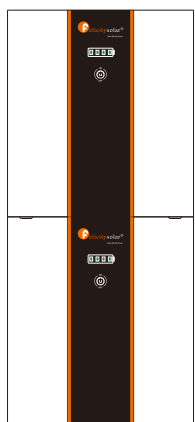

Step 1: The batteries are placed as shown in Figure 1

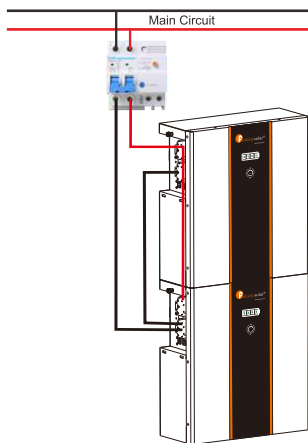

Step 2: The schematic diagram of the parallel connection of two battery packs is shown in Figure 2.

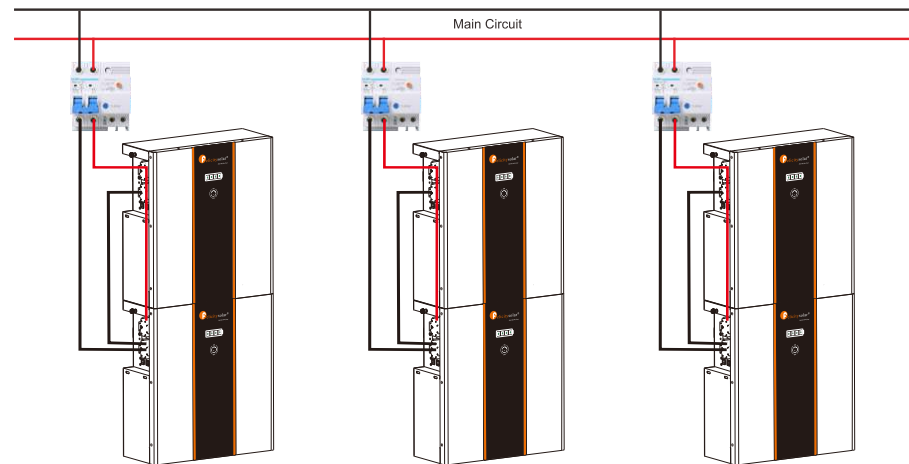

Step 3: The schematic diagram of the parallel connection of six battery packs is shown in Figure 3.

Note: After completing the above 4 steps, arbitrarily select the positive and negative poles of one of the battery packs to output (the upper battery pack or the lower battery pack, you can not select the positive and negative poles of the two battery packs at the same time). After confirming the correct connection of the inverter, controller and battery, you can turn on any of the switches and use the battery group happily.

Note: One group of LPBF24V can be stacked up to 4 layers, and up to 6 in parallel connection
One group of LPBF48V can be stacked up to 2 layers, and up to 6 in parallel connection.

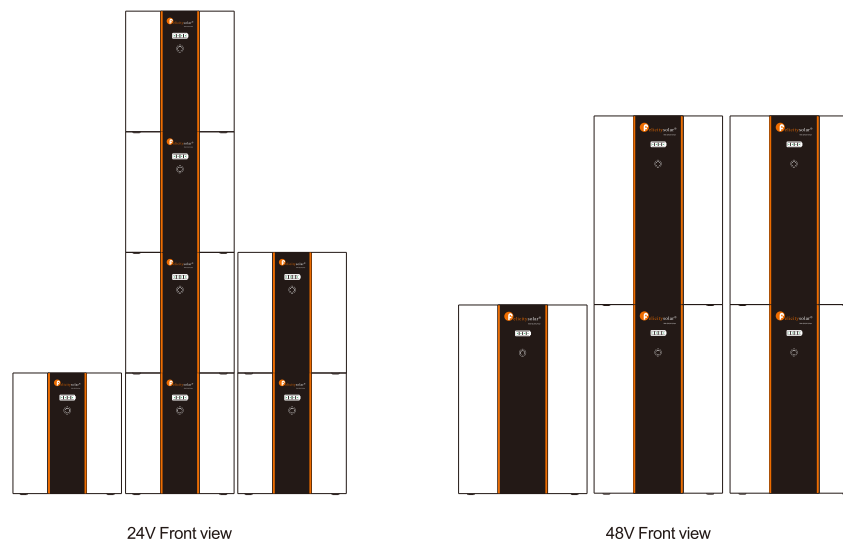

For pure off grid system ,the PV awake wire need to be connected with MPPT charge controller if the battery pack is charged by solar panels only . The connection diagram as below :

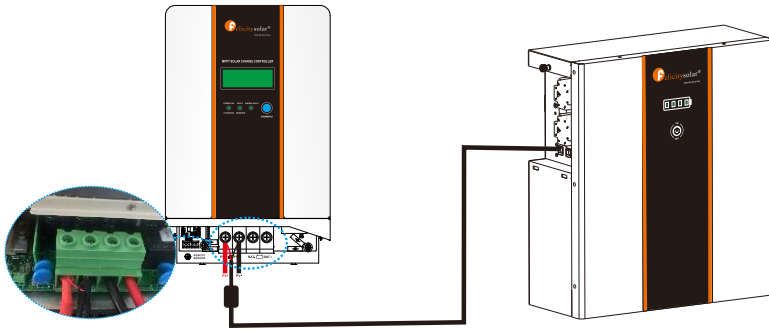

4. OPERATION

Once the batteries are connected well, simply press On/Off button to enable the output of the battery pack.

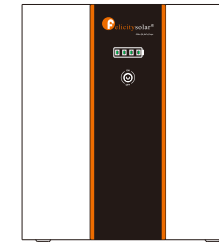

24V Front view

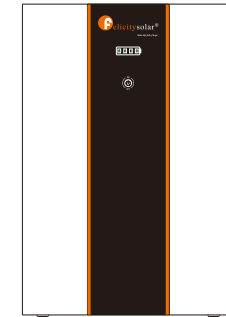

48V Front view

4.1 Switch On / Off

1. Switch on: press On/Off button to switch on the battery, then the battery will do self-inspection before enable output. The LED will show the SOC.
2. Switch off: press and hold On/Off button for 3 seconds, the battery will shut down directly.

Description for Communication port

Picture	PIN	Description
	1	Trigger-GND
	2	Trigger-VCC
	3	NC
	4	COMM-GND
	5	RS485-B
	6	RS485-A
	7	CANL
	8	CANH

DIP SWITCH

	1-4	Communication Address
	5	Termination Resister

4.2 Description for LED

The SOC of the battery is shown by the LED

100%	75%	50%	25%	Flashing SOC < 10%

Note: The battery need to be fully charged for at least once in one month to ensure the accurate SOC calculation.

4.3 ON / OFF or SOC Led (Mode or SOC)

BATTERY MODE	ON/OFF		SOC				REMARK
	GREEN LED	RED LED	LED1	LED2	LED3	LED4	
POWER OFF	OFF	OFF	OFF	OFF	OFF	OFF	
POWER ON	OFF	ON	ON	ON	ON	ON	
STANDBY	OFF	OFF	SOC				SOC<10%(DEFAULT): LED1 FLASH
NORMAL	ON	OFF	RUNNING/SOC				SOC<10%(DEFAULT): LED1 FLASH
DISCHARGE	ON	OFF	SOC				SOC<10%(DEFAULT): LED1 FLASH
CHARGE	FLASH	OFF	RUNNING				
LOW POWER	FLASH	OFF	OFF				
FAULT	OFF	ON	ON	OFF	OFF	OFF	BATTERY VOLTAGE HIGH
			OFF	ON	OFF	OFF	BATTERY VOLTAGE LOW
			ON	ON	OFF	OFF	CELL VOLTAGE HIGH
			OFF	OFF	ON	OFF	CELL VOLTAGE LOW
			ON	OFF	ON	OFF	CHARGING CURRENT HIGH
			OFF	ON	ON	OFF	DISCHARGING CURRENT HIGH
			ON	ON	ON	OFF	BMS TEMPERATURE HIGH
			OFF	OFF	OFF	ON	BMS TEMPERATURE LOW
			ON	OFF	OFF	ON	CELL TEMPERATURE HIGH
			OFF	ON	OFF	ON	CELL TEMPERATURE LOW
ON	ON	OFF	ON	CURRENT SENSOR ABNORMAL			

4.4 DIP switch SW1-SW4 Description

DIP switch SW1-SW4 Description ①					DIP switch SW5 Description ②	
Sw1	SW2	SW3	SW4	Remarks	SW5	Remarks
0	0	0	0	means ID=0,communication address is0x00/0x10③	1	means connect 120Ω resistor
1	0	0	0	means ID=1,communication address is0x01④		
0	1	0	0	means ID=2,communication address is0x02	0	means disconnect 120Ω resistor
1	1	0	0	means ID=3,communication address is0x03		
0	0	1	0	means ID=4,communication address is0x04		
1	0	1	0	means ID=5,communication address is0x05		
0	1	1	0	means ID=6,communication address is0x06		
1	1	1	0	means ID=7,communication address is0x07		
0	0	0	1	means ID=8,communication address is0x08		
1	0	0	1	means ID=9,communication address is0x09		
0	1	0	1	means ID=10,communication address is0x0A		
1	1	0	1	means ID=11,communication address is0x0B		
0	0	1	1	means ID=12,communication address is0x0C		
1	0	1	1	means ID=13,communication address is0x0D		
0	1	1	1	means ID=14,communication address is0x0E		
1	1	1	1	means ID=15,communication address is0x0F		
Remark①: 1 in SW1-SW5 indicates ON status, and 0 indicates OFF status.						
Remark②: When multiple battery packs communicate, the last battery pack SW5 needs to be in the ON status, otherwise the communication may have interference.						
Remark③: When the battery pack ID is set to 0, it means stand-alone operation, and it is not necessary to detect whether the parallel condition is satisfied ⑤						
Remark④: When the battery pack ID is set to 1-15, it means that the parallel operation is required, and it is necessary to detect whether the parallel condition is satisfied ⑤						
Remark⑤: The parallel condition is that the difference between the battery voltage of the local battery and all the battery pack voltages is <3V, otherwise wait until the condition is satisfied						

5. EMERGENCY SITUATIONS

Felicity cannot guarantee eStrong battery absolute safety.

5.1 Fire

In case of fires, make sure that the following equipment is available near the system.

- SCBA (self-contained breathing apparatus) and protective gear in compliance with the Directive on Personal Protective Equipment 89/686/EEC.
 - NOVEC 1230, FM-200, or dioxide extinguisher
- Batteries may explode when heated above 150°C. KEEP FAR AWAY from the battery if it catches fire.

5.2 Leaking Batteries

If the battery pack leaks electrolyte, avoid contact with the leaking liquid or gas. If one is exposed the leaked substance, immediately perform the actions described below.

- Inhalation: Evacuate the contaminated area, and seek medical attention.
- Contact with eyes: Rinse eyes with running water for 5 minutes, and seek medical attention.
- Contact with skin: Wash the affected area thoroughly with soap and water, and seek medical attention.
- Ingestion: Induce vomiting, and seek medical attention.

5.3 Wet Batteries

If the battery pack is wet or submerged in water, do not let people access it, and contact your supplier for help.

Damaged Batteries

Damaged batteries are not fit for use and are dangerous and must be handled with the utmost care. It may leak electrolyte or produce flammable gas. If the battery pack seems to be damaged, pack it in its original container, and then return it to your supplier.

5.4 Warranty

Products that are operated strictly in accordance with the user manual are covered by the warranty. Any violation of this manual may void the warranty.

Limitation of Liability

Any product damage or property loss caused by the following conditions, Felicity does not assume any direct or indirect liability.

- Product modified, design changed or parts replaced.
- Changed, or attempted repairs and erasing of series number or seals;
- System design and installation are not in compliance with standards and regulations;
- The product has been improperly stored in end user's premises;
- Transport damage (including painting scratch caused by movement inside packaging during shipping). A claim should be made directly to shipping or insurance company.